

b08 STRAIGHT
STITCH

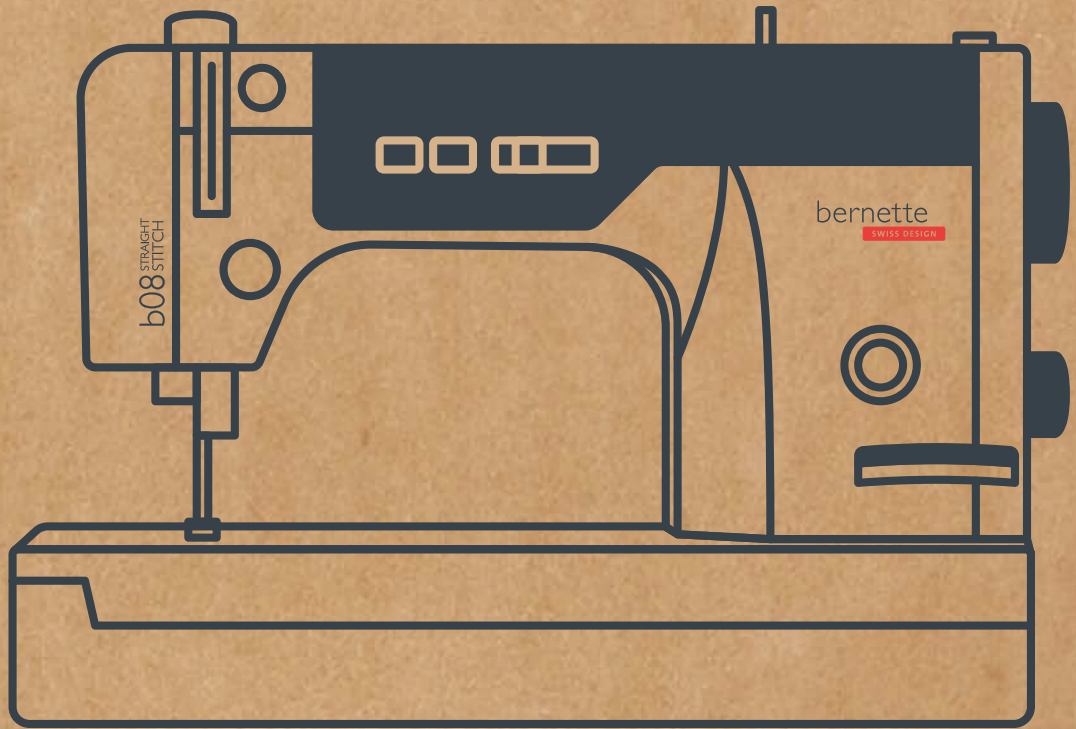

User Manual

bernette
SWISS DESIGN

Table of Contents

IMPORTANT SAFETY INSTRUCTIONS	4	Adjusting the Upper Thread Tension	25
General Information	6	Regulating the Speed	27
1 My bernette	8	Setting the Stitch Length	27
1.1 Overview Machine	8	Setting the Presser Foot Pressure	28
Overview - Front	8	3 Sewing	29
Overview Sewing Area	8	3.1 Quick Reverse	29
Overview of Operating Elements	9	3.2 Automatic Thread Cutter	29
Overview - Back Panel	9	3.3 Sewing thick Areas using the Height Compensation Tool	29
Overview Top	10	3.4 Sewing Corners	29
1.2 Accessory	10	3.5 Sewing Difficult-to-Feed Fabrics	30
Included Accessories	10	3.6 Sewing in a Zipper	30
Overview Presser Feet	11	3.7 Sewing in an Invisible Zipper	31
1.3 Needle, Thread, Fabric	12	3.8 Stitching narrow edges	32
Overview Needles	12	3.9 Edgestitching Using the Seam Guide	32
Thread Selection	12	3.10 Wide Edgestitching	32
Thread and Needle Overview	12	3.11 Sewing hem edges	32
Needle/Thread Combination	13	3.12 Sewing a Narrow Hem	33
2 Sewing Preparation	14	3.13 Sewing Basting Stitches	33
2.1 Connection and Switching On	14	3.14 Gathering	34
Connecting the Machine and Foot Control	14	4 Quilting	35
Switching the Machine On	14	4.1 Free-Motion Quilting	35
Knee Lifter	14	4.2 Sewing Patchwork	35
Positioning the Thread Guide	15	5 Maintenance and Cleaning	37
2.2 Spool Pin	16	5.1 Cleaning the Feed Dog and the Hook	37
Placing the Thread Spool and the Spool Cap	16	5.2 Cleaning the Bobbin Case	37
Using the Spool Net	16	5.3 Lubricating the Machine	38
2.3 Using the Slide-on Table	16	6 Troubleshooting	39
2.4 Needle	17	7 Technical Data	41
Needle Stop Up/Down (Permanent)	17		
Raising and Lowering the Needle	17		
Changing the Needle	17		
2.5 Presser Foot	18		
Raising/Lowering the Presser Foot	18		
Changing the Presser Foot	18		
2.6 Threading	19		
Winding the Bobbin Thread	19		
Threading the Bobbin Thread	20		
Bringing up the Bobbin Thread	21		
Threading the Upper Thread	22		
2.7 Sewing Settings	24		
Adjusting the Lower Thread Tension	24		

IMPORTANT SAFETY INSTRUCTIONS

Please be aware of the following basic safety instructions when using your machine. Before using this machine, read instruction manual carefully.

DANGER!

To reduce the risk of electrical shock:

- Never leave the machine unattended as long as it is plugged in.
- Always unplug the machine from the electrical outlet immediately after using.

Protection against LED radiation:

- Do not view the LED light directly with optical instruments (e.g. magnifier). The LED light corresponds with protection class 1M.
- When the LED light is damaged or defective, contact your bernette specialist dealer.

WARNING

To reduce the risk of burns, fire, electric shock or injury to persons:

- To operate the machine always use the supplied power cable. USA and Canada only: Do not connect power plug NEMA 1-15 to circuits exceeding 150 Volt to ground.
- This machine may only be used for the purpose described in this instruction manual.
- Only use the machine in dry rooms.
- Do not use the machine in a damp condition or in a damp environment.
- Do not use this machine as a toy. You must take extra care if the machine is being used by children or in the vicinity of children.

- This machine may be used by children eight years of age and older as well as persons with restricted physical, sensory or mental capacities or lack of experience and knowledge under supervision or having received instruction on the safe use of the machine and the resulting hazards.
- Children are not allowed to play with the machine.
- Cleaning and maintenance work must not be carried out by children unless they are supervised.
- Do not use this machine if the cable or plug is damaged, the machine is not functioning correctly, it is dropped or becomes damaged or falls in water. Never operate this machine if it has a damaged cord or plug, if it is not working properly, if it has been dropped or damaged, or dropped into water. Contact the nearest authorized bernette dealer to arrange further details.
- Only use the accessories recommended by the manufacturer.
- Do not use this machine if the ventilation openings are blocked. Keep all ventilation openings and foot control free of lint, dust and loose cloth.
- Do not insert any objects into the openings of the machine.
- Do not place any objects on the foot control.
- Always use the machine with a foot control of this type 21381.
- Do not operate the machine where aerosol products (sprays) or oxygen are being used.
- Keep fingers away from all moving parts. Special care is required around the needle.
- Neither pull nor push the fabric while sewing. This can cause needle breakage.

- When making any adjustments in the needle area – such as such as threading the needle, changing the needle, threading the hook or changing the presser foot – turn power switch to «0».
- Do not use bent needles.
- Always use an original bernette stitch plate. The wrong stitch plate can cause needle breakage.
- To disconnect, turn power switch to «0» and then remove the plug from the outlet. Do not unplug by pulling the cord, instead grasp the plug to pull it from the outlet.
- Disconnect the plug before removing or opening the covers, oiling the machine or performing any cleaning or maintenance work described in this instruction manual.
- This machine is double-insulated (except for USA, Canada and Japan). Use only original replacement parts. Note the information on maintaining double-insulated products.

SAVE THESE INSTRUCTIONS

General Information

Availability of the Instruction Manual

The short manual is part of the machine.

The latest version of the detailed instruction manual is available at www.bernette.com/b08#!support.

Keep the short manual of the machine in a suitable place near the machine and have it ready for reference.

When passing on the machine to a third party, enclose the short manual of the machine.

Proper Use

Your bernette machine is conceived and designed for private household use. It is intended for sewing fabrics and other materials as described in this instruction manual. Any other use is not considered proper. BERNINA assumes no liability for consequences resulting from improper use.

Equipment and Scope of Delivery

Example images are used in these instructions for the purposes of illustration. The machines shown in the images and the accessories shown therefore do not always match the actual items included with your machine. The supplied accessory can vary depending on the country of delivery. You can acquire any accessories mentioned or shown that are not included in the scope of delivery as optional accessories from a specialist bernette dealer. Further accessories can be found at www.bernette.com.

For technical reasons and in order to improve the product, changes may be made to the equipment of the machine and the scope of delivery at any time and without prior notice.

Servicing of Double-insulated Products

In a double-insulated product two systems of insulation are provided instead of grounding. No grounding means is provided on a double-insulated product nor should a means for grounded be added to the product. Servicing a double-insulated product requires extreme care and knowledge of the system and should only be done by qualified service personnel. Replacement parts for a double-insulated product must be identical to the original parts in the product. A double insulated product is marked with the words: «Double-Insulation» or «double-insulated».



The symbol may also be marked on the product.

Environmental Protection

BERNINA International AG is committed to environmental protection. We strive to minimize the environmental impact of our products by continuously improving product design and our technology of manufacturing.



The machine is labeled with the symbol of the crossed-out wastebasket. This means that the machine should not be disposed of in household waste when it is no longer needed. Improper disposal can result in dangerous substances getting into the groundwater and thus into our food chain, damaging our health.

The machine must be returned free of charge to a nearby collection point for waste electrical and electronic equipment or to a collection point for the reuse of the machine. Information on the collection points can be obtained from your local administration. When purchasing a new machine, the dealer is obliged to take back the old machine free of charge and dispose of it properly.

If the machine contains personal data, you are responsible for deleting the data yourself before returning the machine.

Explanation of Symbols

 **DANGER**

Designates a danger with a high risk which can lead to serious injuries or even death unless it is avoided.

 **WARNING**

Designates a medium-risk hazard which can lead to serious injuries if not avoided.

 **CAUTION**

Designates a low-risk hazard which can lead to minor or moderate injuries if not avoided.

NOTICE

Designates a hazard which can lead to material damage if not avoided.

1 My bernette

1.1 Overview Machine

Overview - Front



- | | | | |
|---|---------------------------------|---|---------------------------------|
| 1 | Bobbin Cover | 6 | Thread Take-up Lever |
| 2 | Top Bobbin Cover | 7 | Thread Guide |
| 3 | Thread Cutter | 8 | «Stitch Length» Display |
| 4 | Thread Guide | 9 | Connection for Free Hand System |
| 5 | «Presser Foot Pressure» Display | | |

Overview Sewing Area

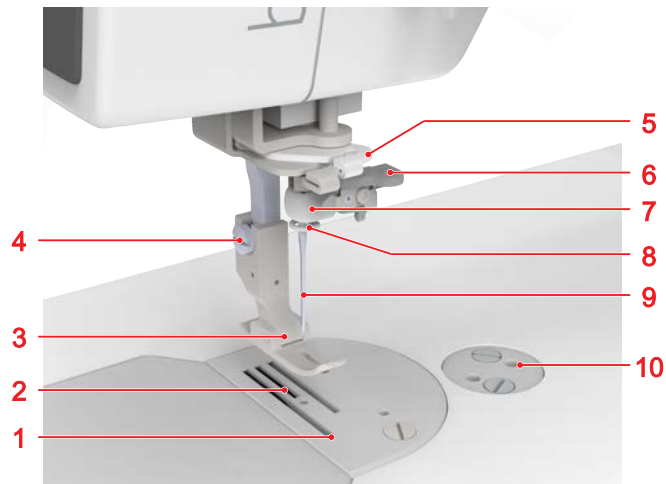

- | | | | |
|---|-------------------------------|----|----------------------------|
| 1 | Stitch Plate | 6 | Needle Threader |
| 2 | Feed Dog | 7 | Needle Holder |
| 3 | Presser Foot | 8 | Needle Holder Thread Guide |
| 4 | Fixing Screw for Presser Foot | 9 | Needle |
| 5 | Thread Guide | 10 | Holes for Attachments |

Overview of Operating Elements



- | | | | |
|---|------------------------------|---|------------------------|
| 1 | «Thread tension» Dial | 5 | Speed Control |
| 2 | «Thread Pretension» Dial | 6 | «Thread Cutter» Button |
| 3 | «Needle Stop Up/Down» Button | 7 | Quick Reverse Lever |
| 4 | «Bobbin Winder» Button | | |

Overview - Back Panel

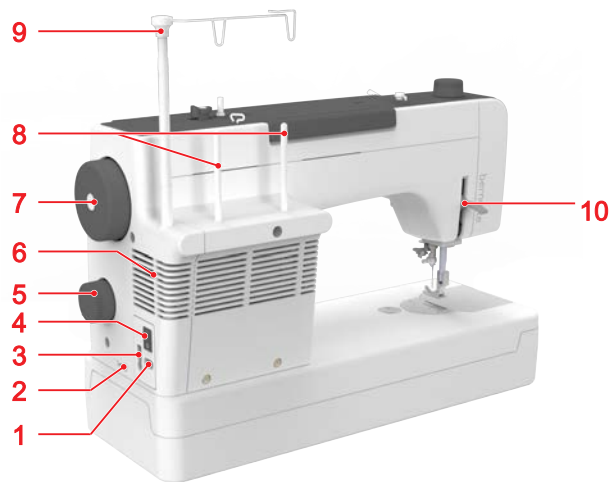

- | | | | |
|---|--|----|--------------------------|
| 1 | Connection Power Cable | 6 | Air Vents |
| 2 | Connection for Automatic Thread Cutter | 7 | Handwheel |
| 3 | Connection for Foot Control | 8 | Spool Pins |
| 4 | Power Switch | 9 | Retractable Thread Guide |
| 5 | Stitch Length Adjustment Dial | 10 | Presser Foot Lifter |

Overview Top

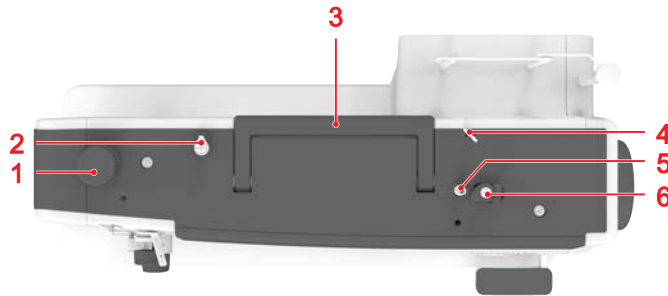

- | | | | |
|---|------------------------------|---|----------------------------|
| 1 | «Presser Foot Pressure» Dial | 4 | Thread Guide |
| 2 | Bobbin Winder Pretension | 5 | Bobbin Winder Unit |
| 3 | Carry Handle | 6 | Stopper Bobbin Winder Unit |

1.2 Accessory

Included Accessories

Visit www.bernette.com/accessories for more accessory information.



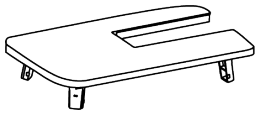
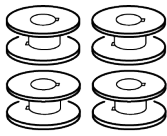
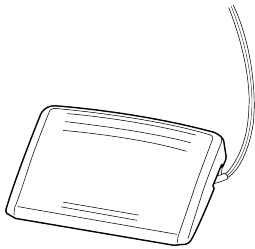
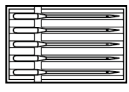
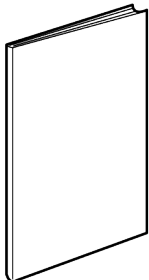
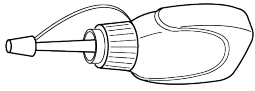
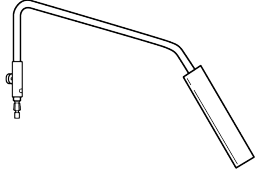
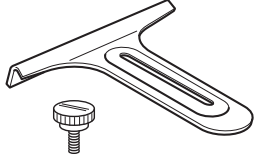

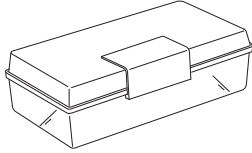

Illustration	Name	Illustration	Name
	Slide-On Table		Bobbin (4x)
	Foot Control		Needle Assortment
	Quick Start Guide		Sewing Machine Oil
	Knee Lifter		Seam Guide

Illustration	Name	Illustration	Name
	Spool net (1x)		Lint Brush
	Accessories Box		Spool Disc, large (1x)
	Screw Driver, large		Screw Driver, small
	Spool Stabilizer		Mettler Thread Starter Kit
	Power Cable		

Overview Presser Feet

Illustration	Name	Purpose
	Straight Stitch Foot	For straight stitch seams on all fabrics.
	Narrow Straight Stitch Foot	For topstitching edges and zippers.

1.3 Needle, Thread, Fabric

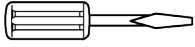
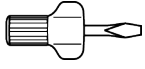
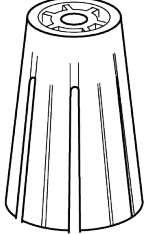
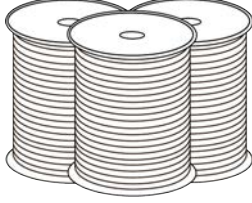
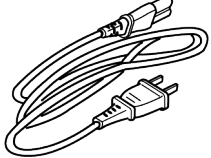
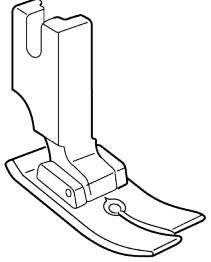
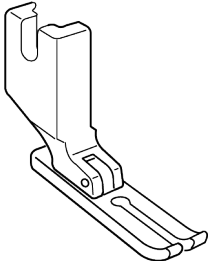
Needles will wear down over time. Therefore, needles should be replaced regularly. Only a perfect point results in a good stitching result. In general it can be said: the thinner the thread, the finer the needle.

- Needle sizes 65, 75: For lightweight fabrics
- Needle sizes 75, 90: For medium fabrics
- Needle sizes 90, 100: For heavyweight fabrics

Overview Needles

Needle	Art. No.
Speed Sewing Needles Special 65/9 HLx5	5020601507
Speed Sewing Needles Special 75/11 HLx5	5020601508
Speed Sewing Needles Special 90/14 HLx5	5020601509
Speed Sewing Needles Special 100/16 HLx5	5020601510
Speed Sewing Needles Special HLx5	5020601511

Thread Selection

For a perfect sewing result, thread and fabric quality play an important role.

We recommend purchasing quality threads to achieve good sewing results.

- Cotton threads have the advantage of being a natural fiber and therefore are especially suitable for sewing cotton fabrics.
- Mercerized cotton threads have a slight sheen that remains even after washing.
- Polyester threads have a high tensile strength and are particularly colorfast.
- Polyester threads are more flexible and are recommended where a strong and elastic seam is required.
- Rayon threads are made of natural fibers and have a brilliant sheen.
- Rayon threads are suitable for decorative stitches and create a more beautiful effect.

Thread and Needle Overview

Fabric		Thread	Needle size (HLx5)
Thin fabrics	Wool	Cotton 50 – 60	65/9
	Foil	Synthetic 50 – 60	75/11
	Gabardine		90/14
	Thin jersey		
	Flannel wool	Synthetic 50 – 60	

Fabric		Thread	Needle size (HLx5)
Thick fabrics	Denim	Synthetic 20 – 50	90/14
	Canvas		100/16
	Imitation leather	Synthetic 20 – 30	
	Tweed fabrics	Cotton 20 – 50	
		Synthetic 30 – 50	
Jersey	Synthetic 20 – 50		

Needle/Thread Combination

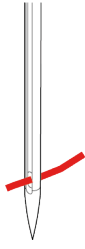
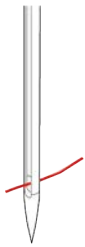
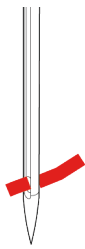
	<p>The needle/thread combination is correct, when the thread fits perfectly into the long groove and goes easily through the needle eye. This allows the thread to be stitched optimally.</p>
	<p>If the thread has too much room to move in the long groove and in the needle eye, this can result in the thread breaking or missing stitches.</p>
	<p>If the thread rubs along the edge of the long groove and cannot be guided properly through the needle eye, this can result in the thread breaking or jamming.</p>

2 Sewing Preparation

2.1 Connection and Switching On

Connecting the Machine and Foot Control

- > Insert the device plug of the power cable into the machine's power cable connection.
- > Insert the power plug of the power cable into the socket.
- > Insert the cable of the foot control into the foot control connection.

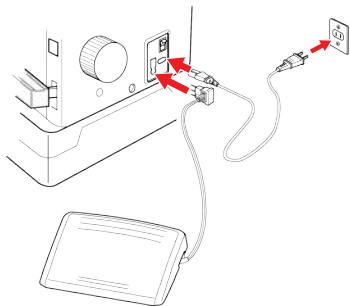

Switching the Machine On

Prerequisite:

- The power plug is connected.
- > Set the power switch to «I».



Knee Lifter

The presser foot may be temporarily raised and lowered with the Free Hand System. The knee lifter is extremely helpful when sewing appliqué, patchwork and quilting since it allows you to handle the fabric while your knee controls the presser foot.

Attaching the Knee Lifter of the Free Hand System

- > Insert the knee lifter into the knee lifter connection.

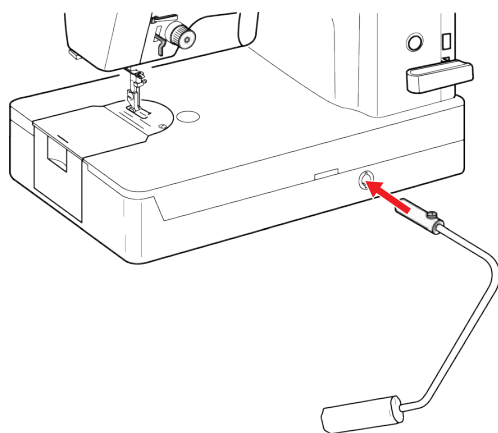

- > Adjust the sitting height so that the Knee Lifter can be operated with the knee.

Adjusting the Knee Lifter

The position and angle of the knee lifter can be optimally adjusted to the individual sitting position.

- > Insert the knee lifter into the knee lifter connection.
- > Loosen the fixing screw and adjust the angle by moving the lifter.

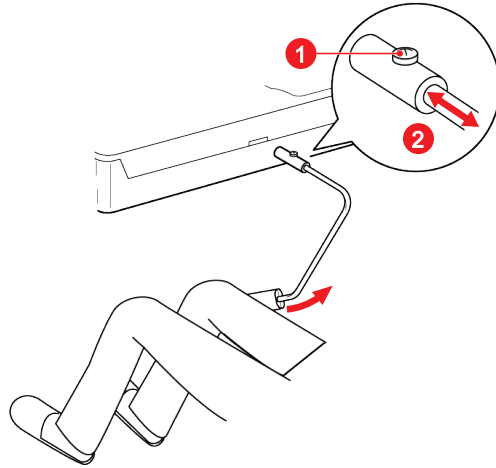

- > Tighten the fixing screw.

Positioning the Thread Guide

The thread guide ensures that the thread is pulled properly from the thread spools. Each thread is guided through a thread guide wire located directly above the thread spool.

- > To position the retractable thread guide, hold the thread guide and pull it up as far as it will go.
- > Turn the thread guide to the left and right until the two positioning pins engage.
 - The outer thread guide wires are parallel to the machine front.

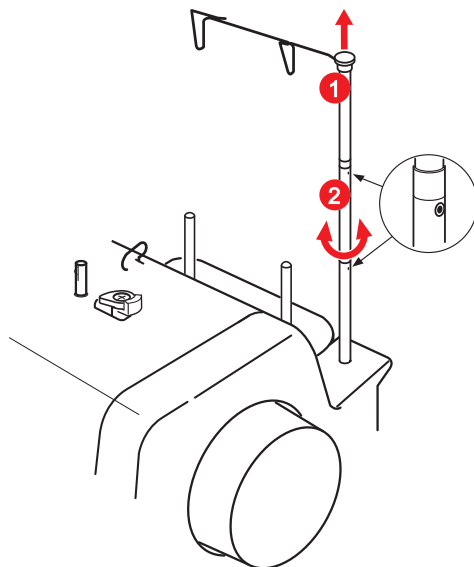

- > To retract the thread guide, push the thread guide down with a little pressure.

2.2 Spool Pin

Placing the Thread Spool and the Spool Cap

Spool discs hold the thread spool in place for proper release of thread from the spool.

- > Place the thread spool on the spool pin.
- > Position the appropriate spool cap on the spool pin so that there is no space between the spool cap and the thread spool.

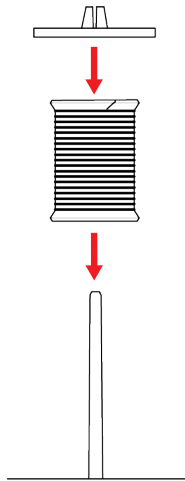

Using the Spool Net

The spool net holds the thread on the thread spool and prevents the thread from knotting and breaking.

- > Pull the spool net over the thread spool. Ensure when doing so that the spool net does not slip off the thread spool, e.g. double-insert the net over the thread spools or insert a part of the net into the thread spool at the rear.

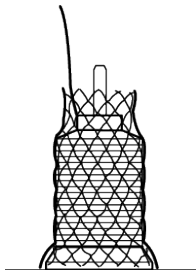

2.3 Using the Slide-on Table



[Video](#)

Attached to the machine, the slide-on table enables the available sewing area to be extended.

- > Unfold the feet of the slide-on table.



- > Push the slide-on table from left to right over the machine bed.

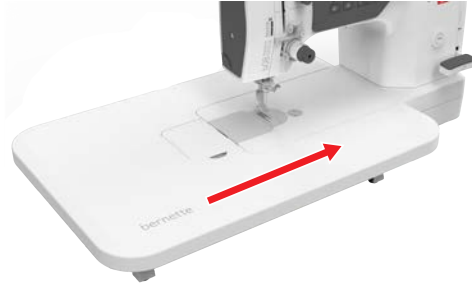

- > Rotate the adjustable feet to adjust the height of the slide-on table.
- > To remove the slide-on table, pull the slide-on table over the machine bed to the left.

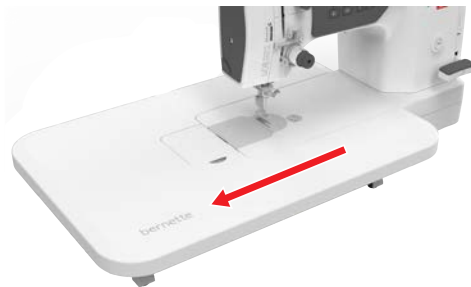

2.4 Needle

Needle Stop Up/Down (Permanent)



- > To set the needle position "down", press the button «Needle Stop Up/Down».
 - The right-hand LED lights up in red.
 - As soon as the foot control is released, the machine stops with the needle in the "down" position.



- > To set the needle position "up", press the button «Needle Stop Up/Down».
 - The left-hand LED lights up in green.
 - As soon as the foot control is released, the machine stops with the needle in the "up" position.

Raising and Lowering the Needle

- > To raise the needle, turn the handwheel counterclockwise until the needle is in the highest position.
- > To lower the needle, continue turning the handwheel counterclockwise until the needle pierces the fabric.

Changing the Needle



[Video](#)

- > Switch the machine off.
- > Lower the presser foot.
- > Raise the needle.
- > Loosen the screw.

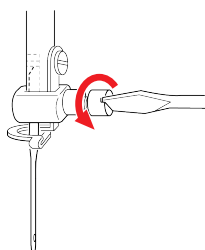

- > Pull the needle down to remove.

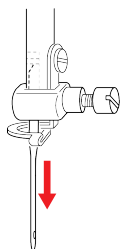

- > Hold the new needle with the flat side to the right and insert it as far up as it will go into the needle holder.

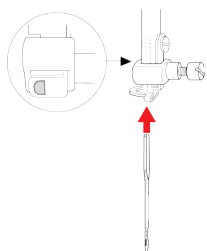

- > Tighten the fixing screw.

2.5 Presser Foot

Raising/Lowering the Presser Foot

- > To raise the presser foot, press the presser foot lever upwards.

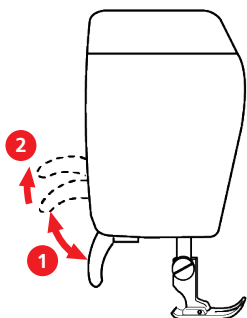

- > To raise the presser foot higher than the normal position, press the presser foot lever all the way up and hold it in place.
- > To lower the presser foot, press the presser foot lever downwards.

Changing the Presser Foot

- > Switch the machine off.
- > Raise the presser foot.
- > Raise the needle.
- > Loosen the fixing screw and remove the presser foot.

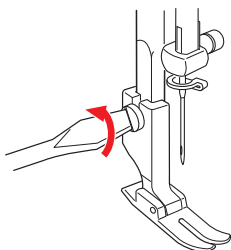

- > Fit the new presser foot and tighten the fixing screw.

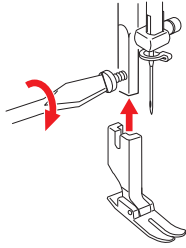

2.6 Threading

Winding the Bobbin Thread



[Video](#)

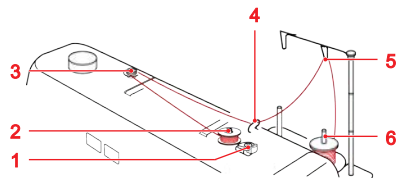

- | | | | |
|---|--------------------------|---|--------------------|
| 1 | Stopper | 4 | Thread Guide |
| 2 | Bobbin Winder Unit | 5 | Thread Guide Wires |
| 3 | Bobbin Winder Pretension | 6 | Spool Pin |

- > To prevent slippery threads from catching or breaking, pull the spool net over the spool.
- > Place the thread spool and the spool disc on the spool pin.
- > Feed the thread through the thread guide wire and the thread guide.
- > Feed the thread around the bobbin winder pre-tensioner.
- > Pull the end of the thread through one of the inner holes on the bobbin and place the empty bobbin on the bobbin winding unit.

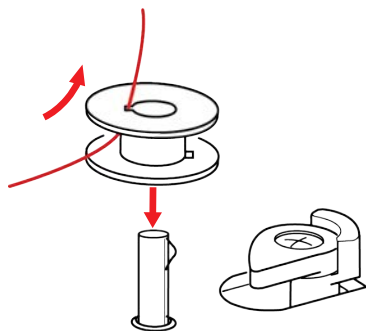

- > Press the stopper of the bobbin winder unit to the left against the bobbin until the position engages.

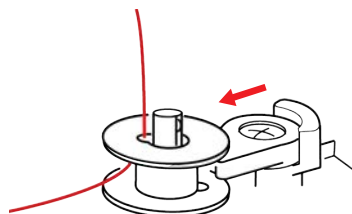



- > Push the button «Bobbin Winder».
 - The machine winds.
- > To stop the winding process, press the button «Bobbin Winder» after a few rotations again.

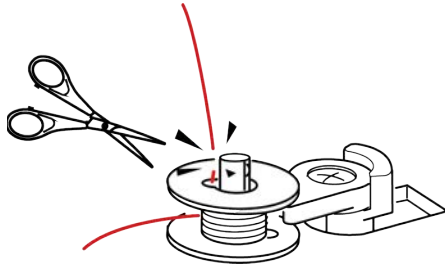

- > Cut the end of the thread just above the bobbin.
- > To start the winding process, push the button «Bobbin Winder».
- > To stop the winding process, push the button «Bobbin Winder» again.
 - As soon as the bobbin is full, the machine stops the winding process automatically.
- > Remove the bobbin and cut the thread.

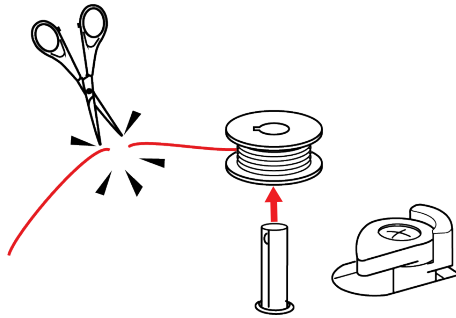

The machine is equipped with a separate winding motor so that winding can also be performed during sewing.

Threading the Bobbin Thread



[Video](#)

- > Raise the needle.
- > Open the bobbin cover.
- > Remove the looper cover.
- > Switch the machine off.
- > Open the bobbin case flap and remove the bobbin case.
- > Insert the bobbin into the bobbin case so that the thread is wound clockwise.

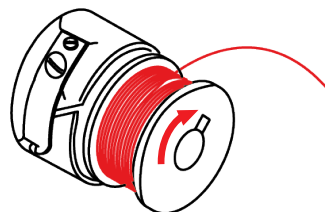

- > Pull the thread into the slit from the right.

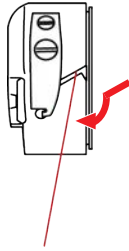

- > Pass the thread further beneath the spring through the opening.

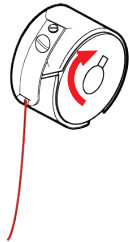

- > Pull the thread to ensure that the bobbin is wound clockwise.

NOTICE**Needle Breakage Caused by Unevenly Wound Bobbins**

Unevenly wound bobbins can lead to incorrect thread tension or cause needles to break.

- > Only use evenly wound bobbins.

- > Hold the bobbin case at the flap and insert it into the hook until it clicks into position.

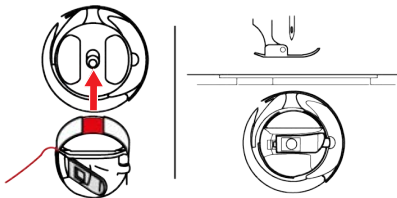

- > Fit the top bobbin cover.
- > Close the bobbin cover.

Bringing up the Bobbin Thread

- > Raise the needle.
- > Raise the presser foot and hold the needle thread lightly with your left hand.

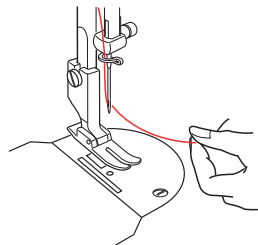

- > Push the button «Needle Stop Up/Down» 2x.

- > Pull the upper thread upwards until the bobbin thread forms a loop.

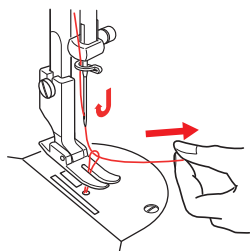

- > Pull the bobbin thread all the way up.
- > Pull both threads approx. 4 in (10 cm) to the back and place them under the presser foot.

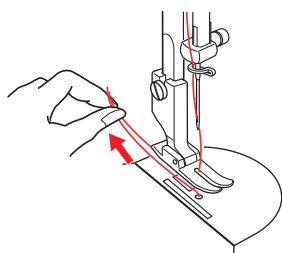

Threading the Upper Thread



[Video](#)

- > Switch the machine off.
- > Raise the needle.
- > Raise the presser foot.
- > Place the thread spool on the spool pin so that the thread unwinds clockwise.
- > Place the thread from the back through the thread guide.

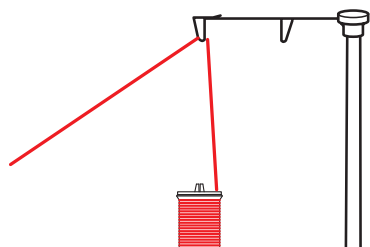

- > Pass the thread through the thread guide plate (1) and then insert the thread between the thread tension discs (2) of the adjusting wheel for the thread pre-tension. **Note:** If the thread tends to twist a lot, feed the thread through the 3 holes in the thread guiding plate (A), as shown in illustration (A).

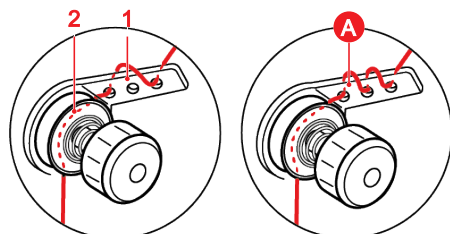

- > Hold the thread with both hands and place it clockwise around the thread tension adjustment wheel (1). Guide the thread over the end of the thread guide spring (2). Pass the thread from bottom to top into the thread guide (3).

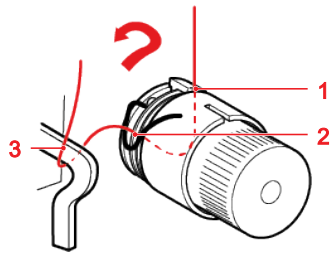

- > **For regular threads:** Hold the thread with both hands and insert it into the guide (1) from below. Feed the thread from right to left through the thread take-up lever (2). Feed the thread through the guide (1) from above.

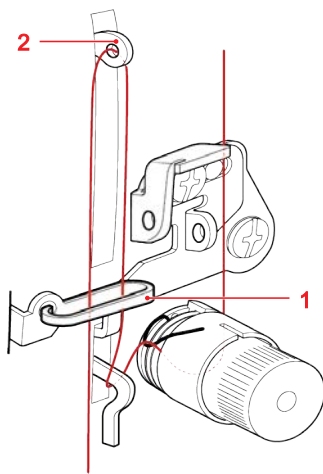

- > **For thicker threads:** Feed the thread through the 2 holes of the thread guide (1). Feed the thread from right to left through the thread take-up lever (2) and down through the guide (3).

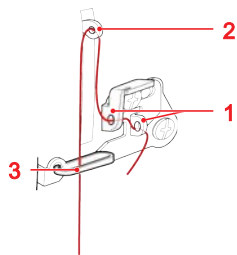

- > Hold the thread with both hands and insert it into the guide from the front left to the back right.

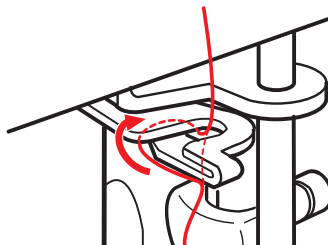

- > Guide the thread through the guides on the right of the needle.

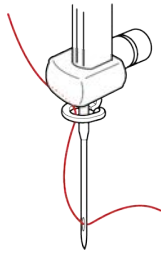

- > Press the threading lever of the needle threader down as far as possible and turn it backwards.

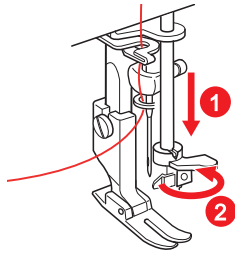

- The wire hook runs through the eye of the needle from the right to the left.

- > Place the thread around the thread guide of the needle threader from the front to the back.
- > Guide the thread to the left of the needle beneath the wire hook and hold it in place.

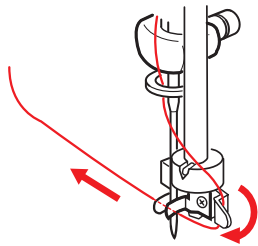

- > Turn the threading lever forwards and release it so that it returns to the starting position. While doing so, hold the thread loosely.

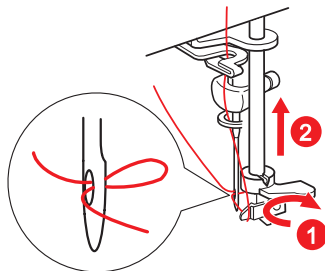

- The wire hook pulls the thread to the right through the eye of the needle to form a loop.

- > Pull the thread completely through the eye of the needle.

2.7 Sewing Settings

Adjusting the Lower Thread Tension



[Video](#)

The bobbin thread tension is preset at the factory to suit standard threads. When using thicker or special threads, e.g. elastic threads, it may be necessary to adjust the bobbin thread tension. Always perform a sewing test before adjusting the bobbin thread tension.

- > Insert the bobbin with thread into the bobbin case.

- > Hold the end of the thread and let the bobbin case drop down once abruptly.

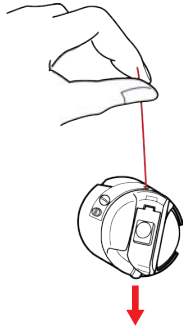

- If the thread runs continuously out of the bobbin case, the bobbin thread tension is too low.
- If the thread does not run out of the bobbin case, the bobbin thread tension is too high.
- > To increase the thread tension, turn the larger screw on the bobbin case to the right.
- > To reduce the thread tension, turn the larger screw on the bobbin case to the left.

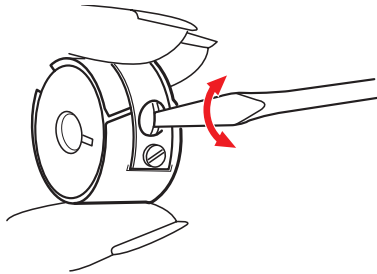

Adjusting the Upper Thread Tension



[Video](#)

Adjusting the Upper Thread Tension with the Adjusting Dial

The upper thread tension can be adjusted using the adjusting dial «thread tension». The default value for the upper thread tension is 3.

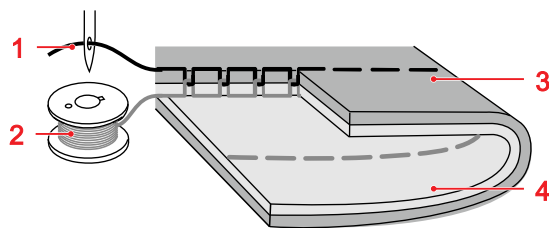

- | | | | |
|---|---------------|---|--|
| 1 | Upper Thread | 3 | Right side (top side) of the fabric |
| 2 | Bobbin Thread | 4 | Wrong side (bottom side) of the fabric |

With an optimal straight stitch, the bobbin thread is not visible on the right side of the fabric.

- > If the bobbin thread is visible on the right side of the fabric, adjust the upper thread tension to a lower value using the adjusting wheel.

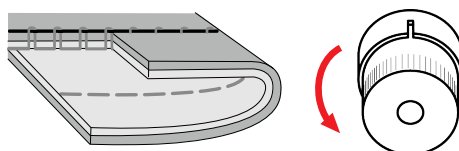

- > If the upper thread is visible on the wrong side of the fabric, adjust the upper thread tension to a higher value using the adjusting wheel.

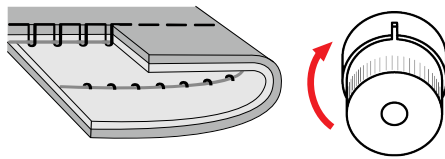

Adjusting the Upper Thread Tension in the Thread Guide (Thicker Threads)

Additionally, the upper thread tension can be altered by moving the adjustment plate.

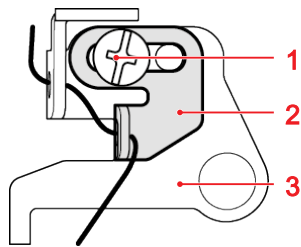

- | | | | |
|---|------------------|---|--------------|
| 1 | Fixing Screw | 3 | Thread Guide |
| 2 | Adjustment Plate | | |

- > To reduce the upper thread tension, loosen the fixing screw, slide the adjustment plate to the left and tighten the fixing screw.

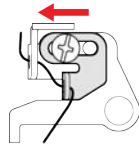

- > To increase the upper thread tension, loosen the fixing screw, slide the adjustment plate to the right and tighten the fixing screw.

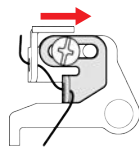

Adjusting the Upper Thread Tension in the Thread Pretension

Additionally, the upper thread tension can be altered by turning the adjusting wheel «Thread Pretension». By turning, the tension between the thread tension discs is changed. The default setting specifies that the screw head sinks about 4 mm (1/8 to 3/16") into the adjusting wheel.

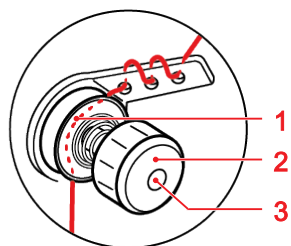

- | | | | |
|---|------------------------|---|------------|
| 1 | Thread Tension Discs | 3 | Screw Head |
| 2 | Thread Pretension Dial | | |

- > To reduce the upper thread tension, turn the adjusting wheel counterclockwise.

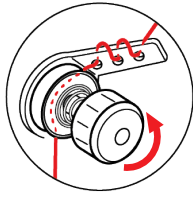

- > To increase the upper thread tension, turn the adjusting wheel clockwise.

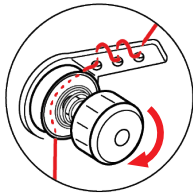

Regulating the Speed



[Video](#)

Regulating the Speed with the Speed Control

The maximum possible sewing speed is infinitely variable via the speed control.

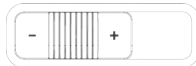

- > To reduce the sewing speed, move the speed control to the left.
- > To increase the sewing speed, move the speed control to the right.

Regulating the Speed via the Foot Control

The sewing speed can be continuously varied up to the maximum possible speed via the foot control.

- > Press the foot control down carefully to start the machine.
- > To sew more quickly, press the foot control further down.
- > Release the foot control to stop the machine.

Setting the Stitch Length

The stitch length can be set from 0 – 6 mm by turning the adjustment dial «Stitch Length».

- > Turn the adjustment dial «Stitch Length» (1) until the desired stitch length is shown on the stitch length display (2).

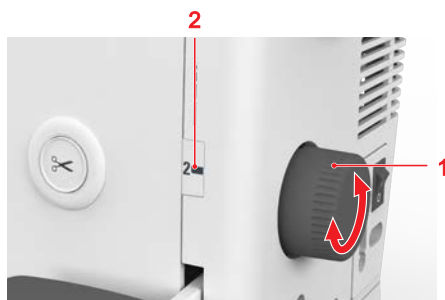

Setting the Presser Foot Pressure



[Video](#)

The presser foot pressure can be set via the adjusting dial «Presser Foot Pressure».



The presser foot pressure is designed to adjust the pressure of the presser foot optimally to the fabric thickness. When working with thick fabrics, it is recommended to reduce the presser foot pressure. This provides the advantage that the fabric can be moved more easily. When working with thin fabrics, it is recommended to increase the presser foot pressure. This provides the advantage that the fabric cannot be moved too easily under the presser foot.

- > To increase the presser foot pressure, turn the adjusting dial «Presser Foot Pressure» clockwise.
- > To reduce the presser foot pressure, turn the adjusting dial «Presser Foot Pressure» counterclockwise.

Note: Do not reduce the presser foot pressure below «0», otherwise the fabric will not be fed.

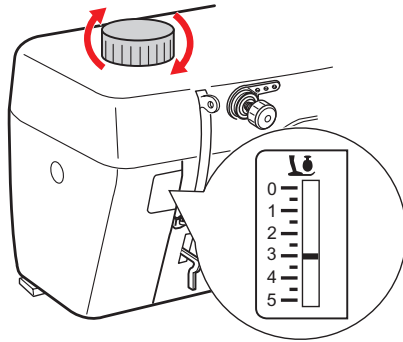

3 Sewing

3.1 Quick Reverse



[Video](#)

Sewing in reverse is used at the beginning and end of the seam to secure the seam.

- > Press the lever «Quick Reverse» and keep it pressed.



- > Press the foot control.
 - The machine sews in reverse until the lever «Quick Reverse» is released.

3.2 Automatic Thread Cutter



[Video](#)

The automatic thread cutter can be activated for thread thicknesses from 30 and higher. The thread cutter on the head frame must be used for thread thicknesses below 30.

The function of the automatic thread cutter may vary for special threads.



- > To cut the upper thread and the bobbin thread automatically, press the «Thread Cutter» button.

3.3 Sewing thick Areas using the Height Compensation Tool

The height compensation tool (optional accessory) is a useful aid when sewing over thick areas.

- > Once the highest point has been reached, lower the needle and raise the presser foot.
- > Level the height of the presser foot by placing one, two or three height compensation plates under the presser foot and behind the needle.

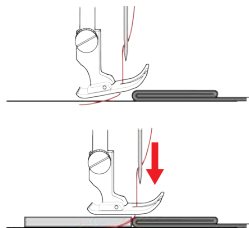

3.4 Sewing Corners



- > Activate the «Needle stop down».
- > Stop the machine when the corner is reached.
- > Raise the presser foot.

- > Use the needle as a pivot and turn the fabric.

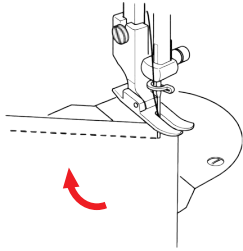

- > Lower the presser foot and continue sewing.

3.5 Sewing Difficult-to-Feed Fabrics

Materials that are difficult to slide such as leather, artificial leather, plastic or vinyl can be easily sewn using the straight stitch foot with non-stick sole (optional accessory).

- > Fit the straight stitch foot with non-stick sole.
- > Set the required stitch length.
- > Sew at a slow, constant speed. Adjust the presser foot pressure and the thread tension if necessary.

3.6 Sewing in a Zipper

As the fabric feed can be difficult when starting to sew, it is recommended to hold the threads firmly or to pull the fabric slightly to the back for a few stitches or to sew 0.5 - 1 in (1 - 2 cm) reverse first.

- > Set the stitch length to «0,5 – 4».
- > Set the thread tension to «4 – 5».
- > Set the presser foot pressure to «3 – 5».
- > Fit the adjustable zipper foot (optional accessory).
- > Loosen the screw, adjust the position of the zipper foot in relation to the needle and tighten the screw.

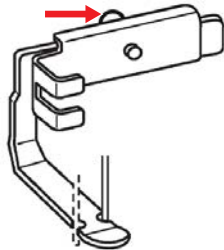

- > To sew the right side of the zipper, position the zipper foot to the right of the needle.
- > Lower the zipper foot at the end of the zipper so that the needle pierces the fabric next to the fold and the zipper tape.

- > To sew the left side of the zipper, position the zipper foot to the left of the needle.

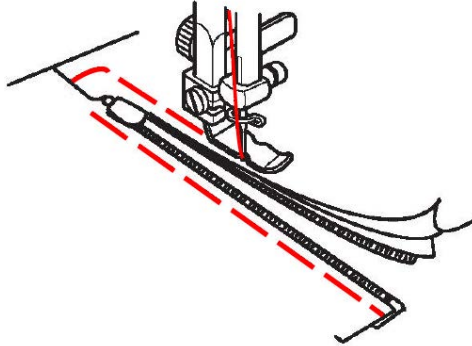

3.7 Sewing in an Invisible Zipper



As the fabric feed can be difficult when starting to sew, it is recommended to hold the threads firmly or to pull the fabric slightly to the back for a few stitches or to sew 0.5 - 1 in (1 – 2 cm) reverse first.

For seam-covered zippers, the Invisible zipper foot (optional accessory) is required.

- > Set the stitch length.
- > Open zipper all the way.
- > Pin the right half of the zipper right side on right side on the fabric.
- > Fit the invisible zipper foot.
- > Baste the zipper on the garment. To do this, place a thick piece of paper between the zipper and the fabric.

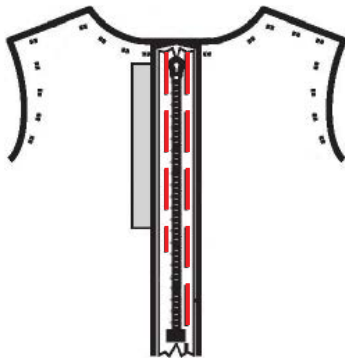

- > Remove the center basting thread and open the zipper.

- > Sew the right and left sides of the zipper to the ends of the zipper opening.

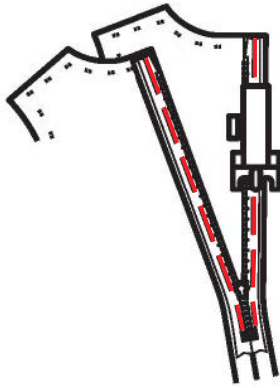

3.8 Stitching narrow edges

- > Fit the narrow straight stitch foot.
- > Set the required stitch length.
- > Place the edge on the left against the narrow straight stitch foot.

3.9 Edgestitching Using the Seam Guide

When sewing parallel wide top-stitching lines, we recommend guiding the seam guide along a sewn line.

- > Set the required stitch length.
- > Fit the seam guide to the holes for attachments and adjust the desired distance to the needle.

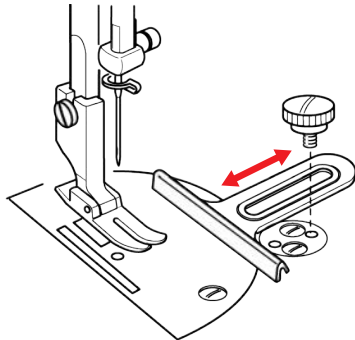

- > Tighten the screw.

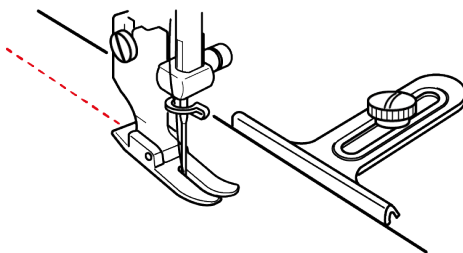

3.10 Wide Edgestitching

- > Fit the seam guide and adjust the desired distance to the needle.
- > Set the required stitch length.
- > Guide the fabric edge along the seam guide.

3.11 Sewing hem edges

- > Set the required stitch length.
- > Attach the Straight Stitch Foot or the Narrow Straight Stitch Foot.
- > Guide the inner, upper hem edge on the right along the edge of the presser foot.

3.12 Sewing a Narrow Hem

The hemmer foot (optional accessory) is required.

- > Fit the hemmer foot.
- > Set the required stitch length.
- > Fold the edge of the fabric by approx. 3 mm and fold it over again. Fold the first 5 cm of the fabric edge to be sewn over.

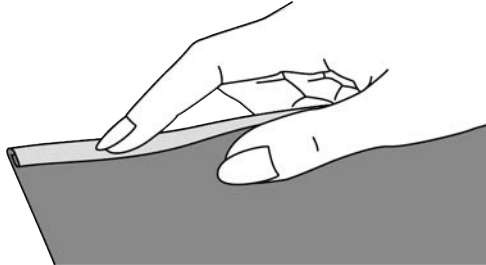

- > Place the fabric edge with the wrong side of the fabric facing upwards under the presser foot, slightly less than the width of the presser foot.
- > Sew 4 – 5 stitches.
- > Raise the needle and presser foot.
- > Pull the fabric backwards by about 10 – 15 cm. Do not cut the thread.
- > Hold the 4 threads in your left hand. Pull the edge of the fabric into the spiral guide on the hemmer foot using your right hand.

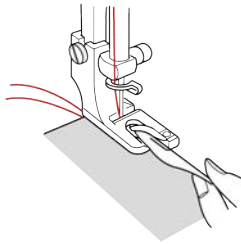

- > Lower the presser foot.
- > Continue sewing slowly while slightly folding the cut edge of the fabric in front of the hemmer foot and holding it to the left. Guide the edge of the fabric evenly into the spiral guide on the hemmer foot and sew.

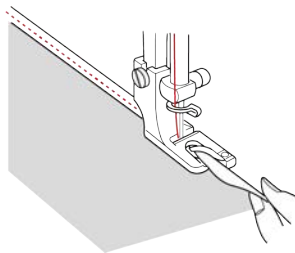

3.13 Sewing Basting Stitches

The basting stitch is suitable for basting several layers of fabric. When sewing basting stitches, it is recommended to use a fine darning thread. The darning thread is easier to remove.

- > Fit the straight stitch foot.
- > Set the maximum stitch length.



Pin the fabric layers at a right angle to basting direction to prevent the layers from slipping.

3.14 Gathering

Ideal for fine and medium-weight fabrics. To decorate clothes or decorative items.

- > Fit the straight stitch foot.
- > Set the stitch length to «4».
- > Set the thread tension to «2» or less.
- > Pull out the upper and bobbin threads by approx. 5 in (20 cm).
- > Sew along the fabric edge at the width of the foot. Sew with a few reverse stitches at the beginning. Leave the thread ends about 4 – 5 in (10 – 12 cm) long when finished.
- > Sew an additional line at a distance of approx. 1/4 in (5 mm). Sew with a few reverse stitches at the beginning. Leave the thread ends about 4 – 5 in (10 – 12 cm) long when finished.
- > Pull the bobbin threads and spread the little pleats evenly.

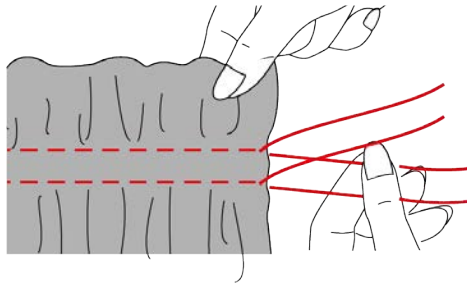

4 Quilting

4.1 Free-Motion Quilting

The quilting stitch plate (optional accessory) and the free-motion quilting foot (optional accessory) are used for quilting work.

It is recommended to use the slide-on table. With free motion quilting, it is of advantage to quilt from the center outwards and to guide the fabric using smooth, round movements to form the design of your choice.

With stipple quilting, entire surfaces of the fabric are filled with quilt stitches. The single lines of stitching are rounded and never cross one another.



Quilting gloves with rubber nubs make it easier to guide the fabric.

Prerequisite:

- The top layer, the batting and the backing are pinned together or basted.
- > Fit the quilting stitch plate.
- > Remove the presser foot and fit the free-motion quilting foot to the presser foot bar.
- > Tighten the free-motion quilting foot with the screw.
- > Set the stitch length «0».
- > If required, adjust the upper thread tension.
- > Press the foot control.
- > Hold both hands close to the presser foot like an embroidery hoop to guide the fabric.
- > If the thread is lying on top of the fabric, slow down the movement of the sewing project.
- > If there are knots on the wrong side of the fabric, move the sewing project faster.

4.2 Sewing Patchwork

Piecing

- > Fit the patchwork foot (optional accessory).
- > Set the stitch length to «0.5 – 4».
- > Set the thread tension to «4 – 5».
- > Set the presser foot pressure to «3 – 5».
- > Place 2 pieces right sides together.
- > Sew the pieces together with a seam allowance of 5 mm or guide them along the guide of the patchwork foot.

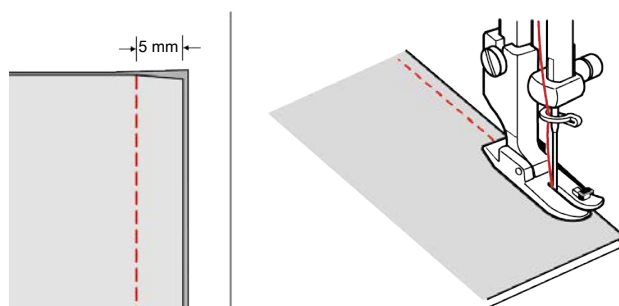

> Press the seam allowances open.

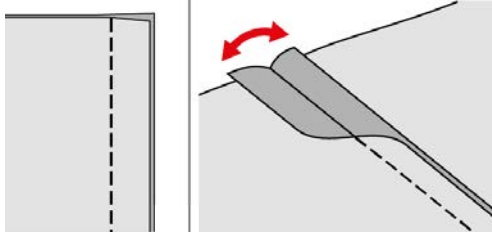

5 Maintenance and Cleaning

5.1 Cleaning the Feed Dog and the Hook



Video

Remaining threads under the stitch plate must occasionally be removed.

CAUTION

Electronically Driven Components

Risk of injury near the needle and the hook.

> Switch off the machine and disconnect it from the power supply.

- > Remove the presser foot and the needle.
- > Open the bobbin cover and remove the top bobbin cover.
- > Loosen both screws and remove the stitch plate.

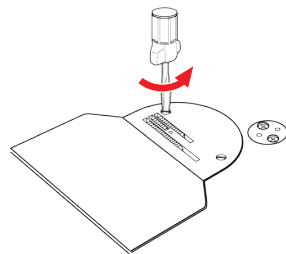

- > Remove the bobbin case and the bobbin.
- > Clean the feed dog and the hook with the brush.

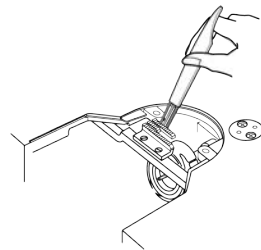

- > Refit the stitch plate. Insert both screws and tighten them.
- > Attach the top bobbin cover and close the bobbin cover.
- > Insert a needle.
- > Attach the presser foot.

5.2 Cleaning the Bobbin Case

CAUTION

Electronically Driven Components

Risk of injury near the needle and the hook.

> Switch the machine off and disconnect it from the power supply.

- > Remove the presser foot and the needle.
- > Open the bobbin cover and remove the top bobbin cover.
- > Remove the stitch plate.
- > Remove the bobbin from the bobbin case.
- > Clean the bobbin case with the brush.
- > Set needle to topmost position.
- > Clean the shuttle race with the brush.
- > Insert the bobbin into the bobbin case.

- > Fit the stitch plate.
- > Attach the top bobbin cover and close the bobbin cover.
- > Fit the needle and presser foot.

5.3 Lubricating the Machine



Video

By oiling the hook, the occurrence of unwanted noises in the hook area can be avoided. Only use the supplied sewing machine oil «M0-70» or alternatively the sewing machine oil «OP-8J» or «Klüber OY 100» for this sewing machine. bernette recommends oiling the hook at the following occasions:

- Prior to the machine's first use
- after a longer downtime of the machine
- in case of intensive use: daily before sewing
- in case of unwanted noises in the hook area



CAUTION

Electronically Driven Components

Risk of injury near the needle and the hook.

- > Raise the presser foot.
- > Switch the machine off and disconnect it from the power supply.

- > Lubricate the marked areas with 3 drops of oil each.



- > Remove the bobbin case.
- > Clean the hook race area with a brush and a soft cloth. Never use any sharp instruments.
- > Lubricate the marked areas with 1 drops of oil each on the felt.

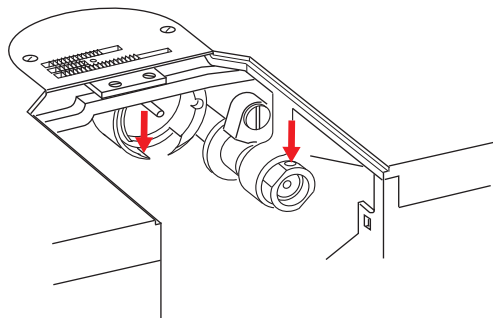

- > Turn the handwheel counterclockwise a few times and remove any excess oil with a cloth.
- > Insert the bobbin case.
- > Sew on a test fabric.

6 Troubleshooting

Fault	Possible Cause	Troubleshooting
Uneven Stitch Formation	Upper thread too tight or too loose.	> Adjust the upper thread tension. (see page 25)
	Needle blunt or bent.	> Replace the needle, make sure that a new BERNINA quality needle is used. (see page 17)
	Poor quality needle.	> Use a new needle.
	Poor quality thread.	> Use quality thread.
	Incorrect needle/thread combination.	> Match the needle with the thread size.
	Incorrectly threaded.	> Rethread.
	Fabric was pulled.	> Feed the fabric evenly.
	Dust or thread remnants under the tension spring of the bobbin case.	> Cleaning the bobbin case. (see page 37)
Skipped Stitches	Incorrect needle.	> Use needles from the needle system HLx5. (see page 12)
	Needle blunt or bent.	> Replace the needle. (see page 17)
	Poor quality needle.	> Use a new needle.
	The needle is incorrectly inserted.	> Insert the needle with the flat side to the right as far up as it will go and tighten the screw.
	Incorrect needle point.	> Match the needle point to the texture of the material.
Light on the button "Bobbin Winder" does not light up	Lighting Defective.	> Contact your bernette dealer.
Light on the button "Needle Stop Up/Down" does not light up	Lighting Defective.	> Contact your bernette dealer.
Needle Breaks	The needle is incorrectly inserted.	> Insert the needle with the flat side to the right as far up as it will go and tighten the screw. (see page 17)
	Fabric was pulled.	> Feed the fabric evenly.
	Thick fabric has been pushed.	> Use a suitable presser foot for thick fabric, e.g. roller foot. > Use the height compensation tool (optional accessory) when sewing over a thick seam. (see page 29)
	Knotted thread.	> Use quality thread.

TROUBLESHOOTING

Fault	Possible Cause	Troubleshooting
Upper Thread Breaks	Incorrect needle/thread combination.	> Match the needle with the thread size.
	Upper thread is too tight.	> Reduce the upper thread tension. (see page 25)
	Incorrectly threaded.	> Rethread.
	Poor quality thread.	> Use quality thread.
	The hook tip or the stitch hole in the stitch plate is damaged.	> Replace the stitch plate. > Contact your bernette dealer.
Lower Thread Breaks	The bobbin is not inserted correctly.	> Remove and reinsert the bobbin and pull on the thread. – The thread should run easily.
	The bobbin is wound incorrectly.	> Check the bobbin and wind it correctly. (see page 19)
	The stitch hole in the stitch plate is damaged.	> Replace the stitch plate. > Contact your bernette dealer.
	Needle blunt or bent.	> Replace the needle.
Faulty Stitching	Thread remnants in the thread pretension.	> Fold a piece of thin fabric (don't use outer edges) and pull it through the thread tension discs several times.
	Incorrectly threaded.	> Rethread.
	Thread is caught in the hook.	> Remove the upper thread and the bobbin case, turn the handwheel backwards and forwards by hand and remove the thread remnants.
	Incorrect needle/thread combination.	> Match the needle with the thread size.
Thread is not cut	Thread is too thick.	> Cut the thread manually.
The Machine doesn't Start	The machine is switched off.	> Switch the machine on. (see page 14)
	The machine is not connected to the power supply.	> Connect the machine or plug in the power cable. (see page 14)
	The machine is defective.	> Contact the specialized bernette dealer.
	Unfavorable room temperature.	> Place the machine in a warm room one hour before use. > Connect the machine and switch it on.
	The presser foot is raised.	> Lower the presser foot. (see page 18)
	Foot control is not connected.	> Connect the foot control. (see page 14)

7 Technical Data

Term	Value	Unit
Maximum Speed	1600	Stitches per Minute
Measurements (W × H × D)	498 × 338 × 228 (19.6 × 13.3 × 9.0)	mm (in)
Weight	14.6 (32.2)	kg (lb)
Input Voltage	110 230	V V
Energy Consumption	95	W
Sound Pressure Level	< 80	dB (A)
Protection Class (Electrical Engineering)	II	



1600 STITCHES
PER MINUTE



EXTENSION TABLE
INCLUDED



EXTRA LARGE
BOBBIN



2 PRESSER FEET
INCLUDED



www.bernette.com/b08

2026-03 EN
5060800.2.04

© BERNINA International AG
Steckborn CH, www.bernina.com